



Project Type Instructions	Date: August 11 2020 Customer: Thermor Ltd Job Number: TH6674 Item Number: 285DI Designer: Alex Vranjesevic	PO: 24617-00 Revision: A	 Contact: Graphics Department graphics@thermor.in.com
UPC (For Reference Only) 	Reason For Project: New Item: X New Branding: Design Update: N/A:	Artwork is not to be amended or scaled. If any changes are required please send through Thermor office with instructions, and we will amend here and resend artwork through. PLEASE RETURN WITH SIGNATURE	
		Colour Breakdown 	

BIOS

Diagnostics

BIOS Temp Scanner

Non-Contact Forehead Thermometer
285DI (UFR101)

Instruction Manual

11.08.20

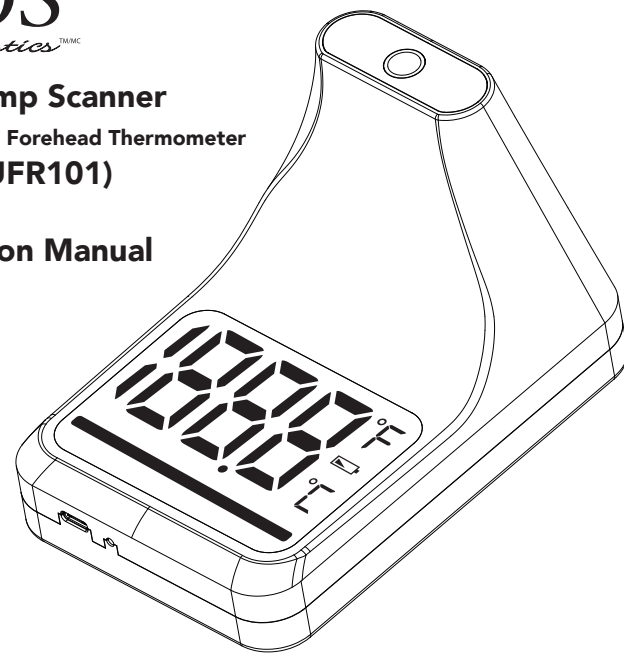







Introduction

- Your new Non-Contact Infrared Forehead Thermometer uses advanced infrared (IR) technology to measure temperature instantly and accurately on the forehead.
- Easy to use and less measurement time**
To ensure safety and hygiene, this thermometer does not need to make contact with the body. Its ergonomic design makes this thermometer simple and very easy to use. It only takes 1 second to take a forehead measurement.
- Body mode**
This thermometer offers a wide measurement range feature from 32°C to 43.0°C (89.6°F to 109.4°F), meaning the unit can be used as a forehead thermometer to measure body temperature.
- Colour visible indication of alarm and alarm sounds**
When body temperature is 37.5°C (99.5°F) or higher, LED light indicator will light up red and an alarm sounds 10 times.
- Measurement**
Measurement time interval in 1 second and the measurement distance is within 1-10 cm.
- Intended Use:**
The Non-Contact Forehead Thermometer is intended for the intermittent measurement and monitoring of human body temperature from the forehead.
- Please read the manual carefully before you use the unit and keep for future reference.

Safety Information

To assure the correct use of the product, basic safety measures should always be followed including the warning and the caution listed in the instruction manual:

Symbol Descriptions:	
The following symbols may appear in this manual, on the label, on the device or on its accessories. Some of the symbols represent standards and compliances associated with the device and its use.	
	WARNING: This alert identifies hazards that may cause serious personal injury or death.
	CAUTION: This alert identifies hazards that may cause minor personal injury, product damage or property damage.
	Type BF applied part
	Manufacturer

	DISPOSAL: Do not dispose this product as unsorted municipal waste. Collection of such waste separately for special treatment is necessary.
	Direct current
	Follow instructions for use

- ▲ Use of this thermometer is not intended as a substitute for consultation with your physician. Infrared thermometers should not be used to manage important health concerns, and therefore parents should not rely solely on temperature readings to evaluate the status of your child's health. If you have any concerns, consult with your doctor.
- ▲ Basic safety precautions should always be observed, especially when the thermometer is used on or near children and disabled persons.
- ▲ Ensure that children **do not** use the instrument unsupervised; some parts are small enough to be swallowed.
- ▲ **It is not recommended to use non-contact infrared thermometers on children under 2 years of age.**
- ▲ Avoid direct sunlight
- ▲ **Do not** touch the lens
- ▲ No modifications of this device is allowed
- ▲ **Do not** use a dilution agent, alcohol or petrol to clean the unit
- ▲ Treat the thermometer gently and **do not** allow the thermometer to fall from high places, this may damage the internal components of the thermometer
- ▲ **Do not immerse the thermometer in liquid**
- ▲ Never leave the battery in the battery compartment for a long time without use, as the battery may leak and cause damage to the unit
- ▲ Remove the battery if you **do not** intend to use it within 3 months. Replace with new batteries if the unit displays a low battery symbol
- ▲ **Do not** mix old and new batteries together

WARNING

 **Do not** dispose of electrical appliances as unsorted municipal waste, use separate collection facilities. Contact your local government for information regarding the collection systems available. If electrical appliances are disposed of in landfills or dumps, hazardous substances can leak into the groundwater and get into the food chain, damaging your health and well-being.

Classification

- Internally powered equipment
- Type BF applied part
- IP21: Protected against vertically falling drops of water or condensation
- Not category AP/APG equipment
- Mode of operation: Continuous operation

▲ The user must check that the thermometer functions safely and see that it is in proper working condition before being used.

Product Diagram

BODY

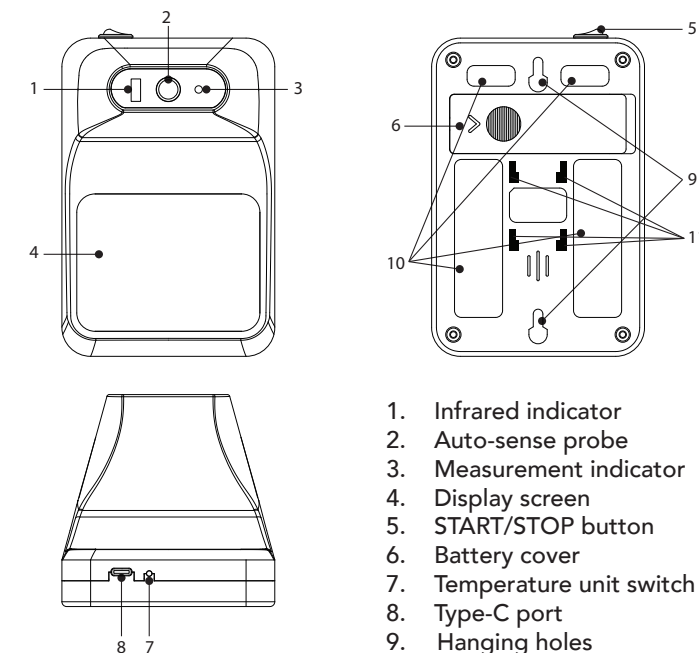

- Infrared indicator
- Auto-sense probe
- Measurement indicator
- Display screen
- START/STOP button
- Battery cover
- Temperature unit switch
- Type-C port
- Hanging holes
- Double sided tape
- Holes for stand adapter

DISPLAY

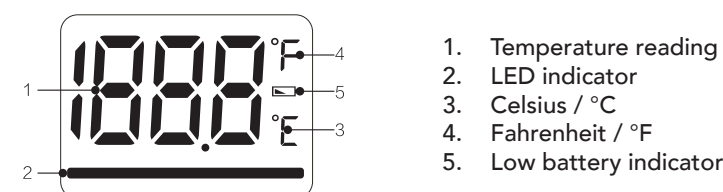

- Temperature reading
- LED indicator
- Celsius / °C
- Fahrenheit / °F
- Low battery indicator

Battery Installation

- Remove the battery cover from the battery compartment according to the arrow direction.
- Insert 1 pc 3.7V 18650 lithium battery, and ensure the battery is in the proper direction. Positive (+) and Negative (-) are displayed on the back of the battery cover.
- Close the battery cover.

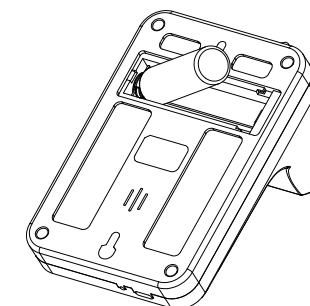

Low Battery and Replacement

When powered on the low battery symbol  will be displayed once the unit starts. Plug in the unit using the included USB cable to charge.

Battery Type (3.7V 18650 Lithium) and Placement

Do not use the battery beyond its expiry date. Please remove the battery if you do not need to use for long periods of time.

Connecting to the Adapter

- Take the USB cable and connect it to the adapter attachment or to your USB port on your computer.
- Connect the end of the USBC tip to the bottom of the thermometer.
- Turn the unit on by pressing the switch to the right located on the top left corner of the thermometer.

Setting Mode

Unit Setting

There is a small hole on the bottom of the device. You can use a 2 mm diameter screwdriver to insert in the hole and then press the button.

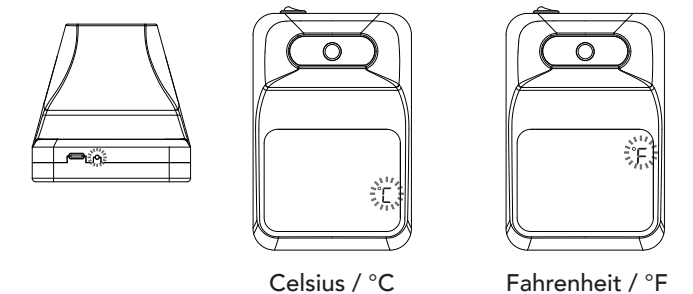

Temperature unit: Press mode switch hole then select °C or °F.

Proper Use of the Unit

Pre-Measurement

About Normal Body Temperature & Fever



Forehead infrared thermometers are intended for measuring body temperature and objects at close proximity. This technology assesses body temperature in one second without having to touch the skin; measurements should be taken within 10 cm / 3.9" of the forehead or temple area.

The temperature at the forehead and temple area differs from internal body temperature, which is taken orally or rectally. Vasoconstriction: an effect which constricts the blood vessels and cools the skin can occur during the early stages of a fever. In this case, the temperature measured by the infrared thermometer may be unusually low. If the measurement does not match the patient's own perception or is unusually low, repeat the measurement every 15 minutes. As a reference, you can also measure the internal body temperature using a conventional oral or rectal thermometer. Body temperature can vary from one individual/person to the next. It also varies by location on the body and time of day. The statistical normal ranges from different body sites are shown below. Please keep in mind that temperatures measured from different sites, even at the same time, should not be directly compared. Fever indicates that the body temperature is higher than normal. This symptom may be caused by infection, overdressing, exercise, or immunization. Some people may not experience fever even when they are ill. These include, but are not limited to, infants younger than 2 years old, persons with compromised immune systems, persons taking antibiotics, steroids or antipyretics (aspirin, ibuprofen, acetaminophen), or persons with certain chronic illnesses. Please consult your physician when you feel ill even if you do not have fever.

Note: When the forehead thermometer is used at cool room temperatures around +20°C to 22°C (68°F to 71.6°F) and your temperature is between 36.0°C to 36.5°C (96.8°F to 97.7°F), by virtue of the products algorithm, a body temperature of 36.3°C (97.3°F) will come up frequently on the display when measuring at the center of the forehead. Measuring at the temple generally yields a higher value because of more blood flow in that region.

Body Site Normal Temperature Range

Body Site	Normal Temperature Range
Oral	0.6°C (1°F) or more Above or below 37°C (98.6°F)
Rectal/Ear	0.3°C to 0.6°C (0.5°F to 1°F) Higher than oral temperature

Project Type Instructions	Date: August 11 2020 Customer: Thermor Ltd Job Number: TH6674 Item Number: 285D1 Designer: Alex Vranjesevic	PO: 24617-00 Revision: A	 Contact: Graphics Department graphics@thermor.in.com
UPC (For Reference Only) 	Reason For Project: New Item: X New Branding: Design Update: N/A:	Artwork is not to be amended or scaled. If any changes are required please send through Thermor office with instructions, and we will amend here and resend artwork through. PLEASE RETURN WITH SIGNATURE	Colour Breakdown 

Axillary (armpit)	0.3°C to 0.6°C (0.5°F to 1°F) Lower than oral temperature
-------------------	--

<https://www.peacehealth.org/medical-topics/id/tw9223>

Using The Thermometer

1. Press the START/STOP button, all symbols appear on the display, you will hear 1 short beep.
2. Move your forehead close to the probe in parallel within the distance between 1 to 10cm. A blue light will show indicating a measurement is being taken.
3. A measurement is taken in 1 second followed by one long beep and a green light will show if no fever is detected. If a fever is detected a red light will show followed by 10 shorts beeps.

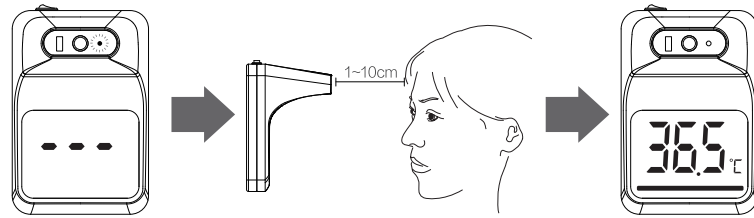

Note:







If the reading is <math><37.5^{\circ}\text{C}</math> (99.5°F) and $\geq 32^{\circ}\text{C}</math> (89.6°F), the display will show together with green LED indicator.$

If the reading is $\geq 37.5^{\circ}\text{C}</math> (99.5°F) and $\leq 43^{\circ}\text{C}</math> (109.4°F), the display will show together with a red LED indicator and 10 short beeps.$$

As the forehead measurement temperature is likely to be affected by sweat, oil and your surroundings, the reading should be taken as a reference only.

- If the probe is placed at an angle close to the forehead measurement, the reading will be affected by surrounding temperature.
- Children's skin reacts very quickly in the ambient temperature. Therefore, do not take their temperature with the non-contact thermometer during/after breastfeeding, because the skin temperature maybe lower than the internal body temperature.

Error Messages

Symbol	Correction
	In Body Mode, Measured temperature is above measuring range of 43.0°C/109.4°F, it is shown in the display with a red LED
	In Body Mode, Measured temperature is below the measuring range of 32.0°C/89.6°F, it is shown on the display with red LED
	Low battery, please connect the charger to charge
	Thermometer system fails or affected by electric magnetic field.
	Green: When charging, the LED indicator shows green
	Red: When charging is complete, the LED indicator light shows red.

Please contact the distributor if you can not solve the problem, do not disassemble the unit by yourself.

Care and Maintenance

Care for the main unit

- Clean the unit with a soft dry cloth. Do not use any abrasive or volatile cleaners.
- Never immerse the unit or any of its' component in water.

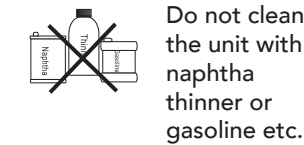

Do not clean the unit with naphtha thinner or gasoline etc.



Store the unit in clean and dry location. Do not subject the unit to extreme hot or cold temperature, humidity and direct sunlight



Remove the battery if the unit will not be used for 3 months or longer.



Do not use the unit under the influence of electromagnetic interference (nearby cellphones, microwaves etc.)

Note: We will not be responsible for any quality problem if you do not care and maintain the product as instructed.

Specification

Display	LED digital display
Measuring Localization	Forehead
Measuring Range	Body mode 32°C to 43.0°C (89.6°F to 109.4°F)
Temperature Unit	°C/°F
Display resolution	0.1°C/0.1°F
Accuracy	$\pm 0.2^{\circ}\text{C}/\pm 0.4^{\circ}\text{F}$
Beep Alarm	<ul style="list-style-type: none"> • 1 short beep when powered on and start measurement • 1 long beep with green LED when measurement reading is below 37.5°C/99.5°F • 10 short beeps with red LED when measurement reading is greater than or equal to 37.5°C/99.5°F • 3 short beeps with red LED when system fails
LED Colour Indicator	Green: Temperature <math><37.5^{\circ}\text{C}</math> (99.5°F) Red: Temperature $\geq 37.5^{\circ}\text{C}</math> (99.5°F)$
Power Source	18650 lithium battery 2000mAh (included) Type-C / USB Adapter
Main Unit Weight	Approx. 151g
Main Unit Size	14 cm x 9.3 cm x 9.3 cm / 5.5" x 3.66" x 3.66"
Accessories	Instruction manual, USB cable, adapter connector, 4 pcs of double sided tape
Operating Environment	Body mode 10.0°C to 40°C/50°F to 104°F
Storage and Shipping Environment	Temperature: - 20°C to 50°C/-4°F to 122°F Humidity:15%-95%RH

2 Year Warranty

BIOS Diagnostics™ Non-Contact Forehead Thermometer has a 2 year warranty to be free of manufacturing defects for the life of the

original owner. The warranty does not cover damage from misuse or tampering.

100% Satisfaction Guarantee

If at any time, you are not completely satisfied with the performance of this device, call our BIOS Medical Hotline and speak with a customer service representative, who will make arrangements to have the device repaired or replaced to your full satisfaction. If you have questions regarding the operation of your thermometer call the BIOS Medical Hotline: 1-866-536-2289

Should repair be necessary, return the unit with all component pieces. Enclose proof of purchase and \$5.00 for return shipping and insurance. Ship the unit prepaid and insured (at owners option) to:

Repair Department
16975 Leslie Street
Newmarket, ON L3Y 9A1
www.biosmedical.com
Email: support@biosmedical.com

Please include your name, return address, phone number, and email address. Thermor will repair or replace (at Thermor's option) free of charge any parts necessary to correct the defect in material or workmanship.

Please allow 10 days for repair and return shipping.

 Follow instructions for use. This document provides important product operation and safety information. Please read this document thoroughly before using the device and keep for future reference.

 Type BF applied part

 Batteries and electronic devices must be disposed of in accordance with the locally applicable regulations, not with domestic waste

MANUFACTURED BY/FABRIQUÉ PAR:
SHENZHEN URION CO. LTD.
GUANGMING NEW DISTRICT, 518106 SHENZHEN
PEOPLE'S REPUBLIC OF CHINA

BIOS | Medical
MANUFACTURED FOR/FABRIQUÉ POUR:
THERMOR LTD.
16975 LESLIE STREET
NEWMARKET, ON L3Y 9A1
MADE IN CHINA/FABRIQUÉ EN CHINE